

# 5 Tier Boltfree Shelf Unit

Shed Accessories

## ASSEMBLY INSTRUCTIONS

**Tool Required - Mallet**

### PARTS LIST

8 x Plastic Feet



5 x MDF Shelves

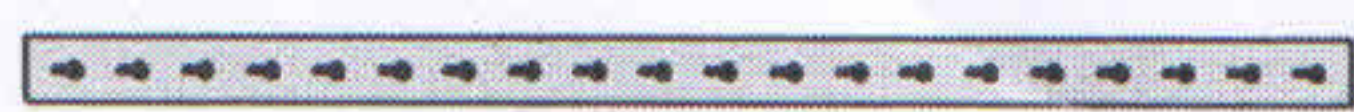

8 x Keyhole Uprights

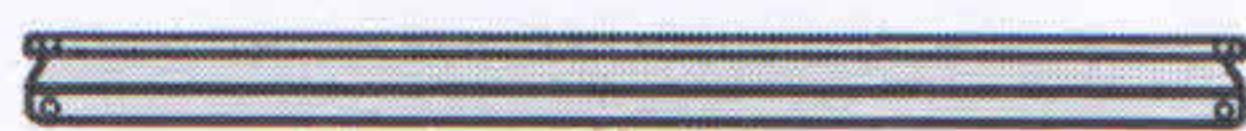

10 x Long Shelf Supports

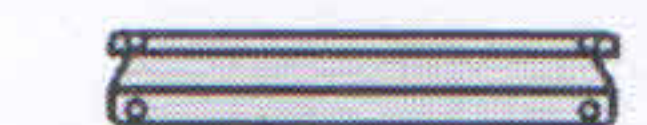

10 x Short Shelf Supports

### SHELF POSITION RECOMMENDATIONS

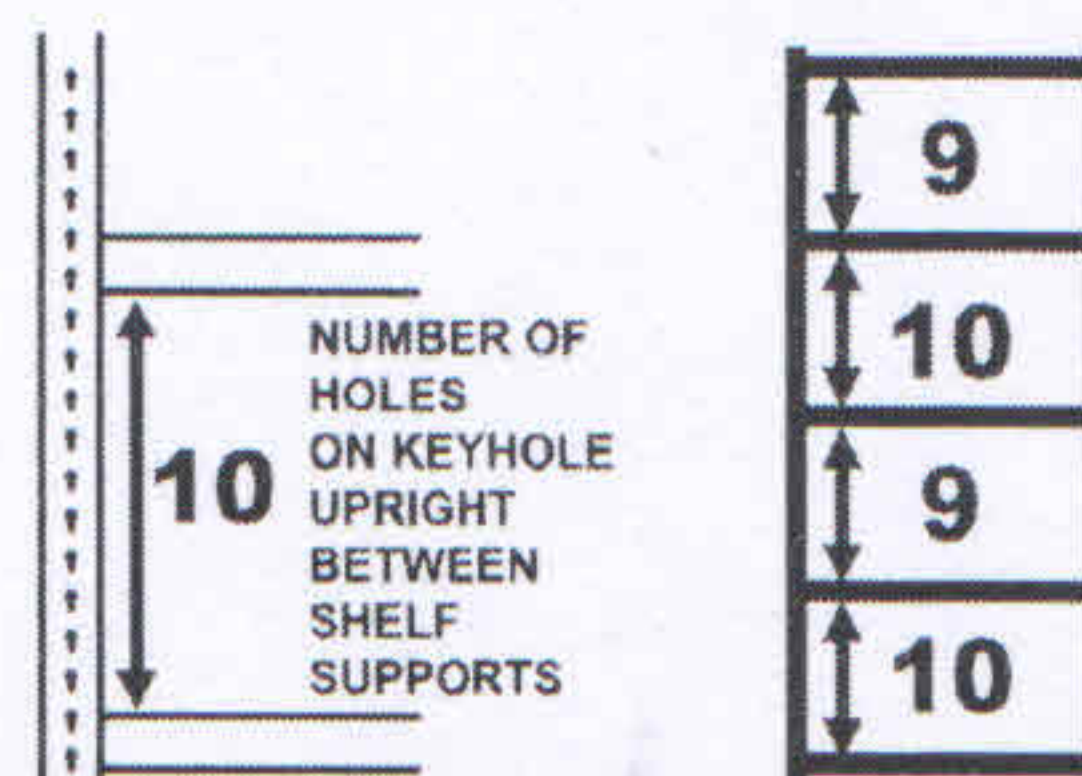

- 1** Attach a Plastic Foot to 1 end of 4 of the Keyhole Uprights. NOTE: Ensure keyholes are the correct way up. (Pic 1)

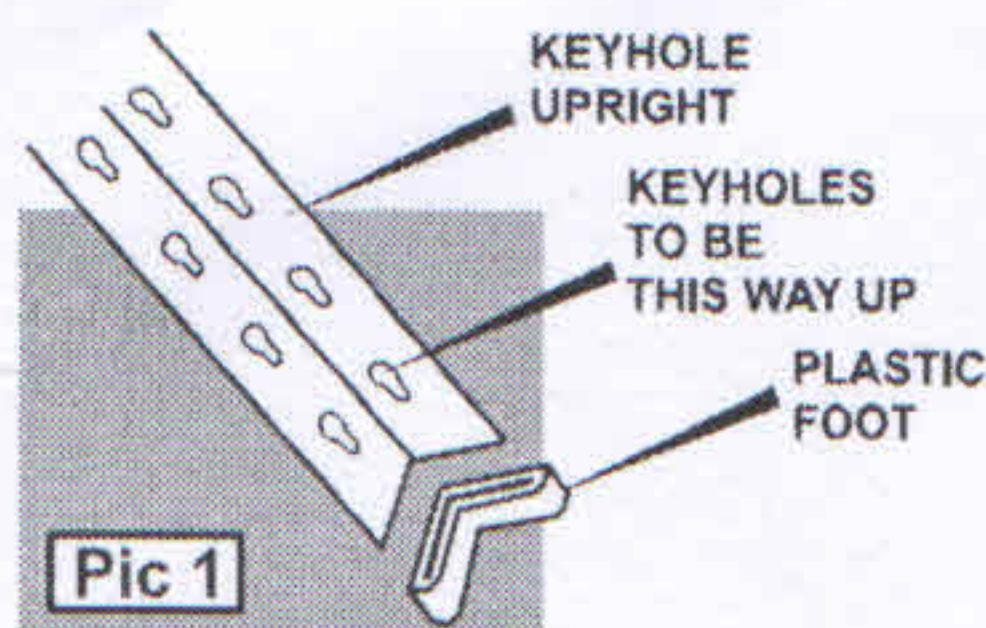

- 2** Fit 2 Short Shelf Supports and 2 Long Shelf Supports to the bottom holes (for maximum strength) of 4 Keyhole Uprights by slotting the Keylock Pins in the Supports into the Keyholes in the Uprights and tapping firmly with a mallet to seat in place. (Pic 2)

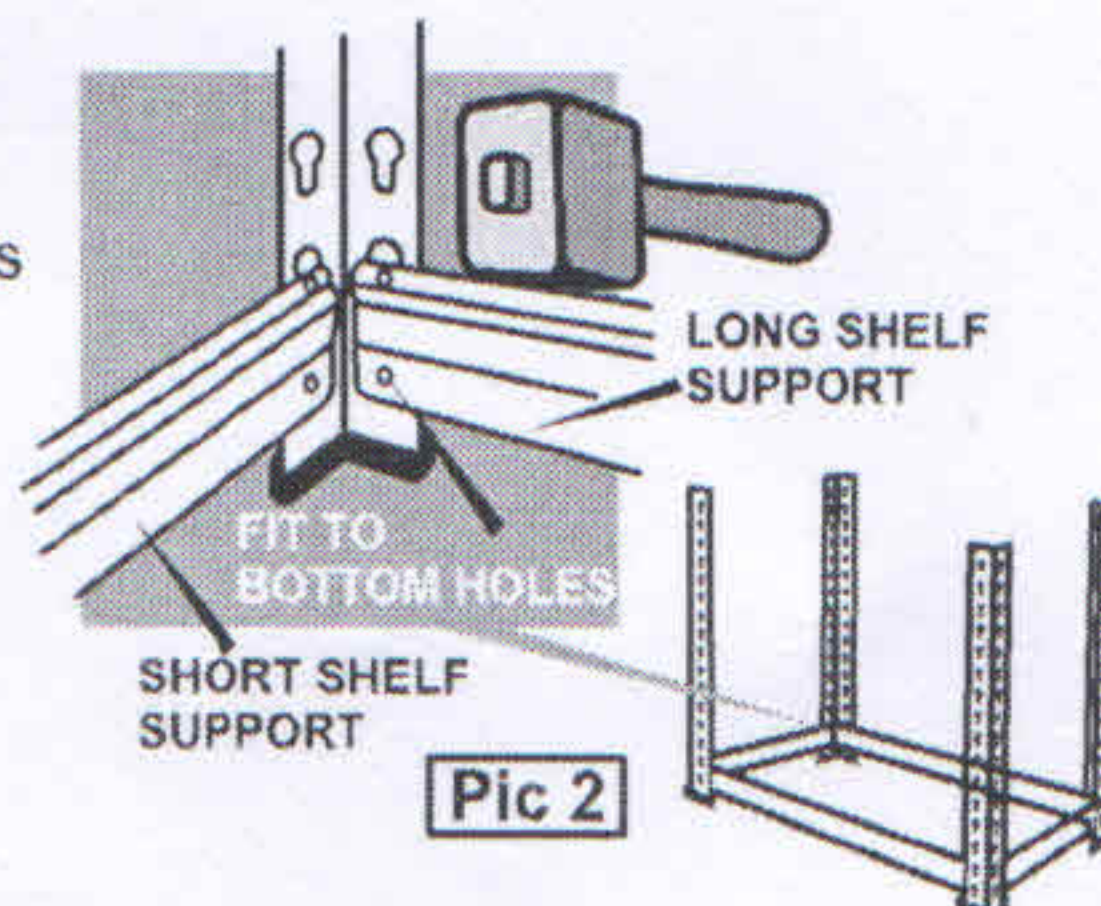

- 3** Fit Long and Short Shelf Supports where you want the 2nd Shelf to be positioned. These Supports must not be in the top 2 holes of the Keyhole Upright. (Pic 3) (We have shelf position recommendations listed below).

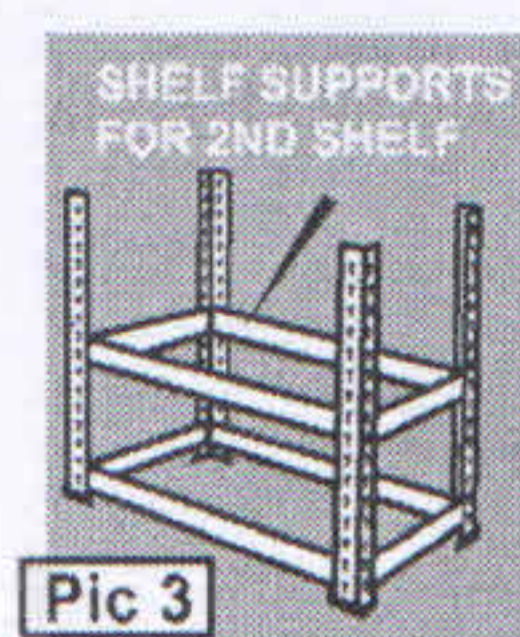

- 4 (GO TO 5 IF YOU ARE NOT ASSEMBLING AS A WORKBENCH)**

- Fit 2 Long Shelf Supports for the top of the Workbench into the holes at the top of the Keyhole Uprights and fit 1 Centre Brace to these Shelf Supports.
- Use the remaining Keyhole Uprights, Long and Short Shelf Supports and Centre Braces to make either a Straight Workbench or a Corner Workbench, using the same method as above.
- Install MDF Shelves.
- Bolt the 2 halves of the Workbench together if needed. (nuts and bolts not supplied).

- 5** To make 1 side of the top half of the Storage Unit: Fit 3 Short Shelf Supports to 2 Keyhole Uprights. Fit the top Support first. It must be located in the top 2 holes of the Upright. Then fit the 4th Support and lastly the 3rd Support to the bottom hole of the Upright. (Pic 4) Repeat this procedure to make the second side. Fit these 2 top halves to the bottom half of the Unit. (Pic 4)

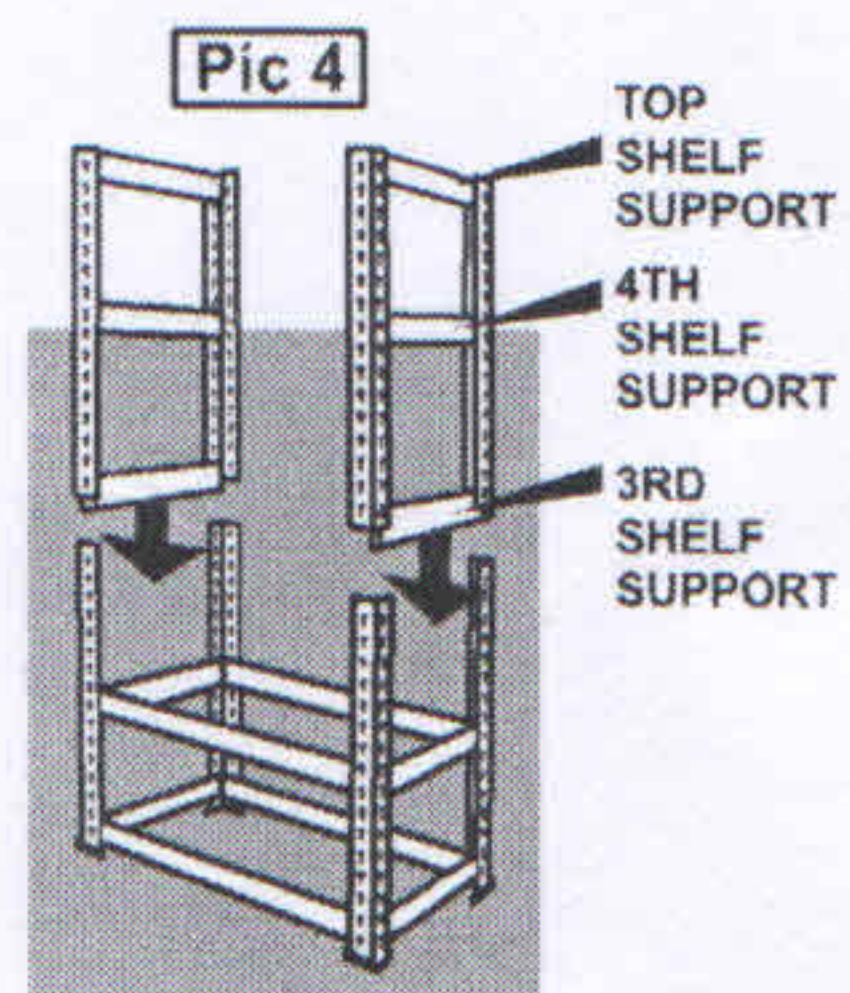
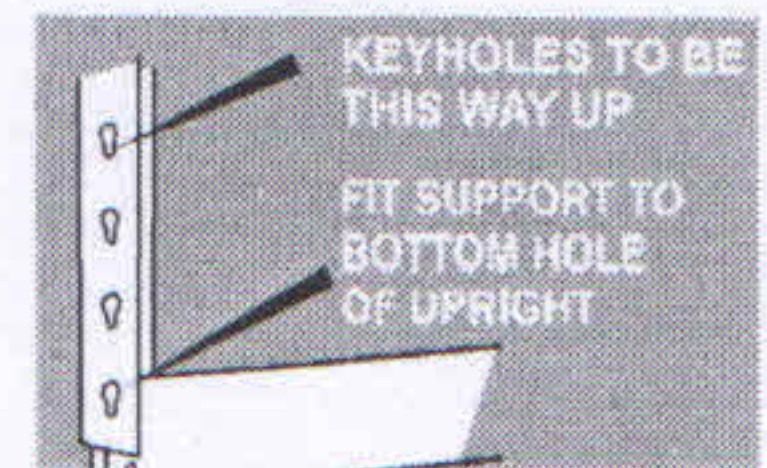

- 6** Fit Long Shelf Supports to the Uprights at the 3rd, 4th and top Shelf positions. (Pic 5)

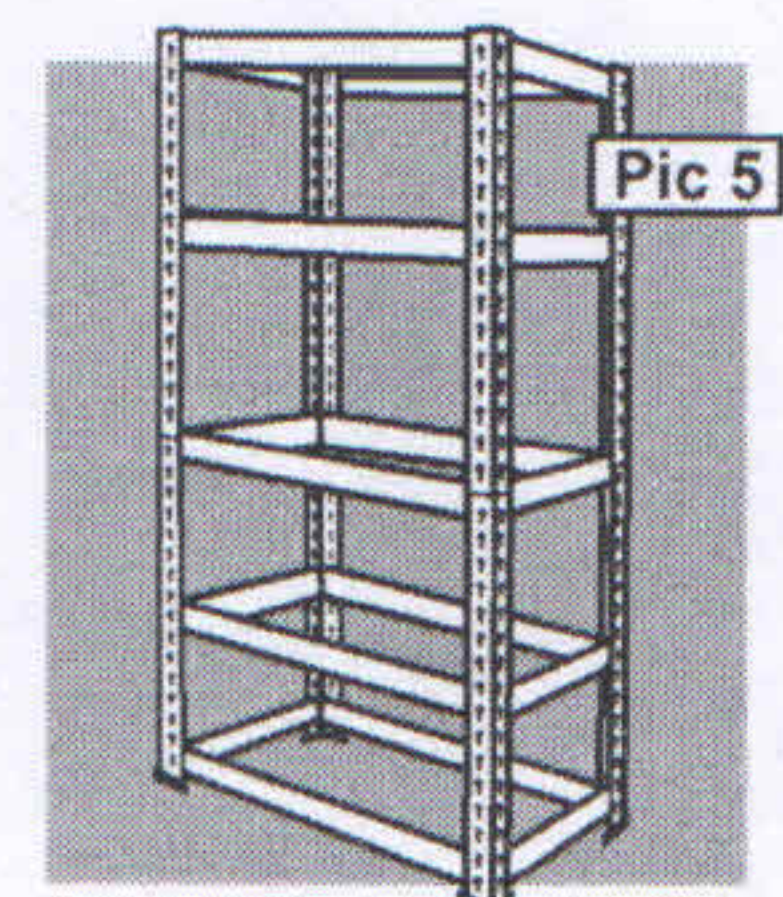

- 7** Place the 5 MDF Shelves onto the 5 Shelf Supports and fit the remaining 4 Plastic Feet to the tops of the Uprights. (Pic 6)

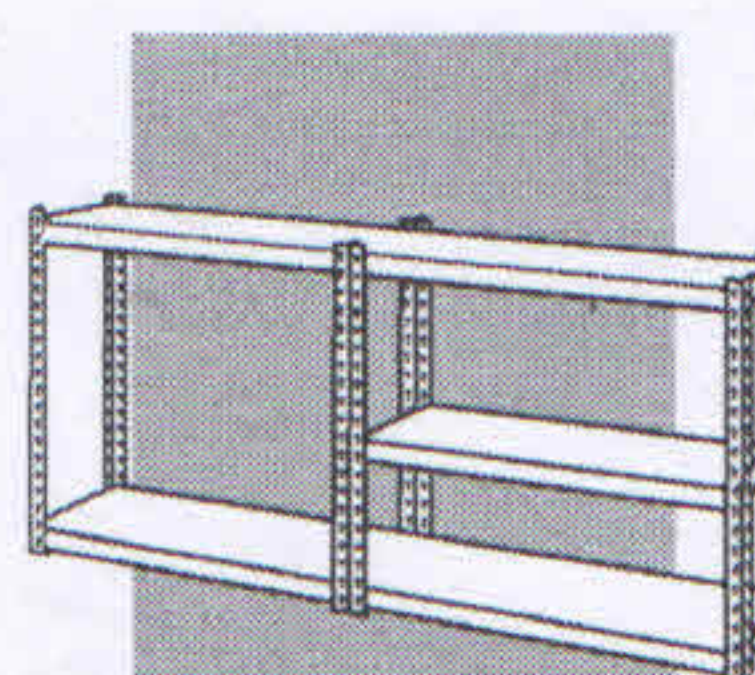
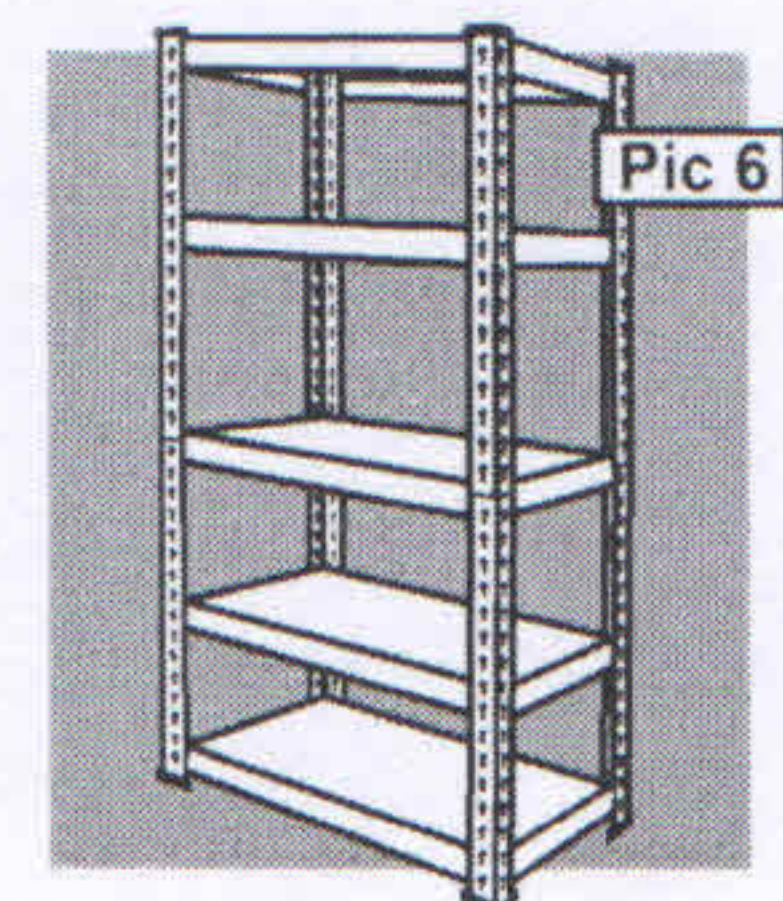

STRAIGHT WORKBENCH

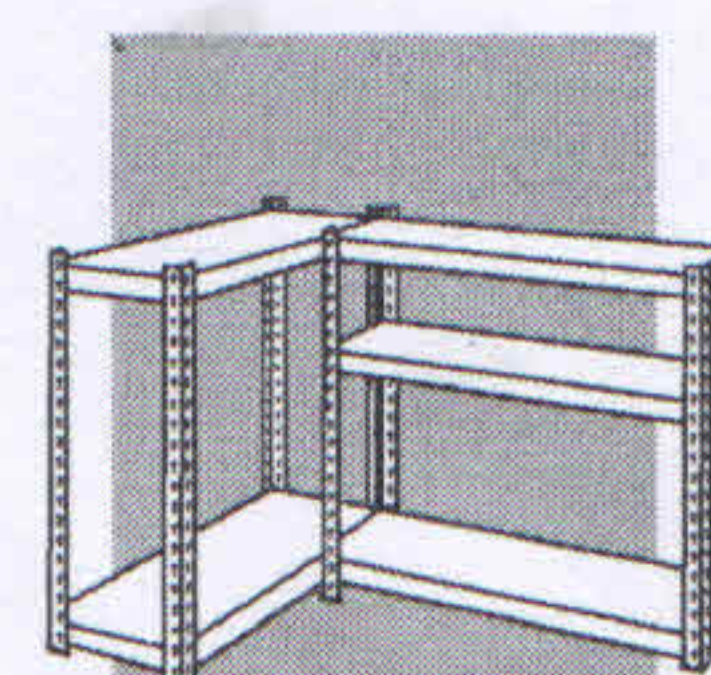

CORNER WORKBENCH